

CATÁLOGO 2019



REPUESTOS AUTOMOTRICES

IMPORTADORA IVAN ARAYA E HIJOS LTDA
BALMACEDA LT A2 02863, LO ESPEJO - SANTIAGO
(+56) 22 8545454 - www.importadoraaraya.cl

INDICE

SOPORTE ESCAPE	-----	PAG. 3 - 5
PEDALES AUTOMOTRICES	-----	PAG. 6 - 8
FUELES DE HOMOCINETICA Y CAJA	-----	PAG. 9 - 11
FUELLES DE DIRECCION	-----	PAG. 11 - 12
FUELLE PALANCA	-----	PAG. 12
GOMA AMORTIGUADOR	-----	PAG. 13
GOMA ALZA ESPIRAL	-----	PAG. 14
SOPORTE TENSOR	-----	PAG. 14 - 16
BARRA ESTABILIZADORA	-----	PAG. 16 - 21
BUJES	-----	PAG. 22 - 29
TOPES DE CHASSIS	-----	PAG. 29 - 30
BUJE DE ACOPLADOS	-----	PAG. 30
TIRANTE DE CAPOT	-----	PAG. 30
SOPORTE CABINA	-----	PAG. 31
TAPONES DE ACEITE	-----	PAG. 31
TOPES DE ELEVADOR	-----	PAG. 31
TOPES DE PARACHOQUES	-----	PAG. 32
GOMAS VARIAS	-----	PAG. 32
SOPORTE MOTOR	-----	PAG. 32 - 35
BARRA DE DIRECCION	-----	PAG. 35
TOPES DE PORTALON	-----	PAG. 36
CUBRE FOCOS	-----	PAG. 36
FLECTORES DE DIRECCION	-----	PAG. 36
REGATONES	-----	PAG. 36 - 37
RETENES	-----	PAG. 37
CARDANES	-----	PAG. 37

SOPORTES ESCAPES

<p>ES-01 SOPORTE ESCAPE LUV</p>		<p>ES-02 SOP ESCAPE ARGOLLA CH. 63 MM</p>	
<p>ES-03 SOP. ESCAPE OPALA 63 MM</p>		<p>ES-04 SOP. ESCAPE RENAULT 18 68 MM</p>	
<p>ES-05 SOP. ESCAPE VOLVO SOP. ESCAPE M. BENZ SOP. ESCAPE PEUG. BOXER 70 MM</p>		<p>ES-06 SOPORTE ESCAPE LADA</p>	
<p>ES-07 SOP. ESCAPE VOLKSWAGEN</p>		<p>ES-08 SOPORTE ESCAPE DAEWOO</p>	
<p>ES-09 SOP. ESCAPE FIAT FIORINO</p>		<p>ES-10 SOP. ESCAPE CITROEN VISA</p>	
<p>ES-11 SOP. ESCAPE TOYOTA XL</p>		<p>ES-12 SOP. ESCAPE TOYOTA HILUX</p>	
<p>ES-13 SOP. ESCAPE OPEL CORSA</p>		<p>ES-14 SOPORTE ESCAPE LUV</p>	
<p>ES-15 SOP. ESCAPE FIAT 125 SOP. ESCAPE LADA</p>		<p>ES-16 SOPORTE ESCAPE FIAT 174</p>	
<p>ES-17 SOPORTE ESCAPE CHEVETTE TRASERO</p>		<p>ES-18 SOP ESC. FIAT 147 TRASERO SOP. ESC. LADA TRASERO</p>	

SOPORTES ESCAPES

<p>ES-19</p> <p>SOP. ESC. HYUNDAI H-100</p>		<p>ES-20</p> <p>SOP. ESCAPE NISSAN V-16</p>	
<p>ES-21</p> <p>SOP. ESCAPE FIAT FIORINO SOP. ESC. FIAT PUNTO TRAS.</p>		<p>ES-22</p> <p>SOP. ESCAPE SUZUKI ST-90 SOP. ESCAPE HYUNDAI</p>	
<p>ES-23</p> <p>SOP. ESCAPE CAVALIER</p>		<p>ES-24</p> <p>SOP. ESCAPE MINI 32 MM</p>	
<p>ES-25</p> <p>SOP. ESCAPE RENAULT 12 SOP. ESCAPE RENAULT 18 26 MM</p>		<p>ES-26</p> <p>SOP. ESCAPE UNIVERSAL 21 MM</p>	
<p>ES-27</p> <p>SOP. ESCAPE UNIVERSAL 19 MM</p>		<p>ES-28</p> <p>SOP. ESCAPE RENAULT 5 24 MM</p>	
<p>ES-29</p> <p>SOPORTE ESCAPE 22 MM</p>		<p>ES-30</p> <p>SOPORTE ESCAPE 11 MM</p>	
<p>ES-31</p> <p>SOP. ESCAPE HONDA</p>		<p>ES-32</p> <p>SOP. TOYOTA TERCEL TRAS. SOP. TOYOTA YARIS</p>	
<p>ES-33</p> <p>SOP. ESCAPE M. BENZ</p>		<p>ES-34</p> <p>SOP. ESCAPE RENAULT 9</p>	
<p>ES-35</p> <p>SOP. ESC. RENAULT CLIO</p>		<p>ES-36</p> <p>SOP. ESCAPE FIAT UNO SOP. ESCAPE FIAT RITMO</p>	

SOPORTES ESCAPES

<p>ES-37</p> <p>SOP. ESCAPE M. BENZ</p>		<p>ES-38</p> <p>SOP. ESC. FORD ESCORD</p>	
<p>ES-39</p> <p>SOP. ESC. PEUG. 405-206</p>		<p>ES-40</p> <p>SOP. ESCAPE CHEROKEE</p>	
<p>ES-41</p> <p>SOP. ESCAPE HONDA SOP. ESCAPE HYUNDAI</p>		<p>ES-42</p> <p>SOP. ESC. PEUG. PARTNER</p>	
<p>ES-43</p> <p>SOP. ESC. TOYOTA YARIS</p>		<p>ES-44</p> <p>SOP. ESC. TOYOTA YARIS</p>	
<p>ES-45</p> <p>SOPORTE ESCAPE MONZA</p>		<p>ES-46</p> <p>SOPORTE ESCAPE KIA</p>	
<p>ES-47</p> <p>SOP. ESC. YARIS CENTRAL</p>		<p>ES-48</p> <p>SOPORTE ESCAPE KIA FILTRO DE AIRE</p>	
<p>ES-49</p> <p>RAD. M. BENZ 608 CHICO 19 MM</p>		<p>ES-50</p> <p>SOP. ESCAPE FORD DEL REY SOP. ESCAPE FORD CORCEL</p>	
<p>ES-51</p> <p>SOP. ESCAPE UNIVERSAL PERNO LARGO</p>		<p>ES-52</p> <p>SOP. ESC. CHEVR. SPARK</p>	
<p>ES-53</p> <p>SOP. ESCAPE MINI 32 MM PERNO LARGO</p>		<p>ES-54</p> <p>SOP. ESC. SUZUKI CELERIO</p>	

PEDALES AUTOMOTRICES

PE-01 PEDAL KIA		PE-02 PEDAL KIA FRONTIER 2,0 PEDAL KIA BESTA - FORD	
PE-03 PEDAL KIA MOTOR 3,5		PE-04 PEDAL CHEVR. LUV ANTIGUA	
PE-05 PEDAL CHEVR. LUV NUEVA		PE-06 ACELERADOR LUV (UNIDAD)	
PE-07 PEDAL PEUGEOT BOXER PEDAL CITROEN C-15 PEDAL CITROEN 2X DIESEL		PE-08 PEDAL NISSAN V-16 DAEWOO, OPEL, MONZA	
PE-09 PEDAL VOLKS. SIBEIRO PEDAL SUBARU LEGACY		PE-10 PEDAL TOYOTA HILUX PEDAL DAIHATSU ROCKY	
PE-11 PEDAL NISSAN V-16 PEDAL NISSAN SENTRA II BLUE BIRD MODERNO		PE-12 PEDAL HYUN. ACCENT PEDAL HYUN. ELANTRA PEDAL HYUN. H-100	
PE-13 PEDAL FIAT UNO PEDAL FIAT 125 POLONES		PE-14 PEDAL NISSAN D-21 NISSAN SUNNY, DATSUN 140Y-150-120 Y CTA.	
PE-15 PEDAL SUZUKI FURGON SUZ. MARUTI, DAEWOO TICO MASTER VAN, CHANGAN Y LIFAN		PE-16 PEDAL SUZUKI FURGON, MARUTI, VITARA, FRONTER SUZUKI ST90, ASIA TOUNER	
PE-17 PEDAL HYUNDAI H-100		PE-18 PEDAL LADA SAMARA	



















PEDALES AUTOMOTRICES

<p>PE-19</p> <p>PEDAL FIAT 174 PEDAL LADA 2106</p>		<p>PE-20</p> <p>PEDAL FIAT 1500</p>	
<p>PE-21</p> <p>PEDAL SEAT PEDAL DAIHA. COURE</p>		<p>PE-22</p> <p>PEDAL PEUGEOT 404 PEDAL KIA POP PEDAL KIA TOUNER</p>	
<p>PE-23</p> <p>PEDAL HYUN. SONATA PEDAL HYUN. SANTAMO PEDAL HYUN. PROTON</p>		<p>PE-24</p> <p>PEDAL SUBARU 1600 PEDAL SUBARU 1800 PEDAL SUBARU LEGACY</p>	
<p>PE-25</p> <p>PEDAL RENAULT 5 PEDAL RENAULT TRAFIC</p>		<p>PE-26</p> <p>PEDAL HONDA PEDAL SUZ. VITARA RACVI</p>	
<p>PE-27</p> <p>PEDAL SUBARU FURGON</p>		<p>PE-28</p> <p>PEDAL PEUGEOT 405</p>	
<p>PE-29</p> <p>PEDAL FORD RANGER</p>		<p>PE-30</p> <p>PEDAL AUSTIN MINI</p>	
<p>PE-31</p> <p>PEDAL DAIHA. FURGON</p>		<p>PE-32</p> <p>PEDAL AUSTIN MINI</p>	
<p>PE-33</p> <p>PEDAL DAIHA. CHARADE</p>		<p>PE-34</p> <p>PEDAL PEUGEOT 306</p>	
<p>PE-35</p> <p>ACELERADOR SUZUKI (UNIDAD)</p>		<p>PE-36</p> <p>ACELERADOR CHEVETTE ACELERADOR CHARADE (UNIDAD)</p>	



















PEDALES AUTOMOTRICES

PE-37 ACELERADOR FIAT FIORINO ACELERADOR FIAT 147 (UNIDAD)		PE-38 PEDAL CHEVETTE ANT.	
PE-39 PEDAL FIAT 600		PE-40 PEDAL VOLVO BUS	
PE-41 PEDAL OPALA PEDAL CHEVETTE 90 PEDAL MITSUBISHI L-300		PE-42 PEDAL CHEVROLET C-10	
PE-43 PEDAL PEUGEOT 504		PE-44 PEDAL DAIH. MAX COURE	
PE-45 PEDAL M. BENZ 608		PE-46 PEDAL M. BENZ 708	
PE-47 PEDAL MITSUBISHI ROSA		PE-48 PEDAL NISSAN QASHQAI PEDAL MERCEDES BENZ	
PE-49 PEDAL VOLVO SCANIA		PE-50 PEDAL MAHINDRA	
PE-51 PEDAL NISSAN TIIDA		PE-52 PEDAL MAHINDRA	

FUELLE HOMOCINETICA Y CAJA

F-01 FUELLE AMORTIGUADOR UNIVERSAL GRANDE	 DS: 17,5 DI: 61 A: 260	F-02 FUELLE AMORTIGUADOR UNIVERSAL CHICO	 DS: 15 DI: 55 A: 195
F-03 FUELLE NISSAN V-16; VECTRA 1.8; SUB. LEGACY HYUN. SONATA - SANTAMO	 DS: 23 DI: 82 A: 100	F-04 FUELLE NISSAN V-16 CAJA	 DS: 21 DI: 73 A: 121
F-05 RANAULT 9; OPEL CORSA SUB. LOYALE; MITSU GALANT CHEVR. MONZA; PEUG. 405 NISSAN PULSAR; DAEWOO HYUN. ELANTRA; NISSAN SUNNY	 DS: 20 DI: 80 A: 97	F-06 NISSAN SENTRA; ASTRA 1,8 SUB. GL 1800; KIA VECTRA 1,8 KIA SPORTAGE 2,0 - 2,2 MAZDA B 2600 MITSUBISHI MORTERO	 DS: 26 DI: 85 A: 110
F-07 DAEWOO RACER - ESPERO CHEVR. CAVALIER LADA NIVA	 DS: 23 DI: 85 A: 115	F-08 FUELLE CORSA 3 FUELLE DAEWOO CAJA FUELLE CORSA 1.6 (2007)	 DS: 21.5 DI: 56 A: 92
F-09 FUELLE HONDA; MAZDA MITSU. LANCER; FORD LASSER; HYUN. EXEL SUBARU 1600	 DS: 21 DI: 72 A: 99.5	F-10 FUELLE SUBARU 1600 CAJA	 DS: 21 DI: 75 A: 97
F-11 FUELLE KIA AVELLA; MAZDA TOY. TERCEL; SUZ. VITARA FORD ESCORT; SUBARU HYUNDAI EXEL	 DS: 21 DI: 80 A: 97	F-12 SUZ. SWIFT (CAJA) - GEMINIS SUZ. MARUTI (RUEDA) - FRONTER DAEWOO TICO; KIA POP NISSAN MARCH - PULSAR	 DS: 19 DI: 65 A: 86
F-13 FUELLE CHARADE FUELLE MINI FUELLE DAIHATSU	 DS: 21 DI: 62 A: 82	F-14 FUELLE MAX COURE FUELLE SUBARU 600	 DS: 22 DI: 68 A: 80
F-15 VOLKS. AMAZON - SIBEIRO FUELLE LADA SAMARA	 DS: 22 DI: 75 A: 74	F-16 FUELLE PEUG. 205 (CAJA) FUELLE FIAT 147	 DS: 22 DI: 70 A: 94
F-17 FUELLE CITROEN VISA; KIA SEPHIA NISSAN SUNNY; PEUG.405-305 SUZ. BALENO - MARUTI VISA FORD DEL REY; REN. 12 (TL)	 DS: 22 DI: 70 A: 98	F-18 FUELLE TOYOTA TERCEL FUELLE TOYOTA COROLLA	 DS: 25 DI: 80 A: 110















FUELLE HOMOCINETICA Y CAJA

F-19 CHARADE; CITROEN C-15 REN. ECLAIRE (CAJA) - 21 REN. MAXIMA - TWINGO CHEVR. CAVALIER		F-20 FUELLE 4 X 4	 DS: 30.5 DI: 98 A: 105
F-21 FUELLE 4 X 4	 DS: 27 DI: 98 A: 130	F-22 FIAT DUCATO; CIT. BERLINGO PEUG. 605-405-306; BOXER PARTNER; MEGANE-LAGUNA CHEVR. MONZA; VOLK. POLO	 DS: 26 DI: 86.6 A: 137
F-23 TOY. TERCEL - TWIN CAM (CAJA) TOYOTA TERCEL (RUEDA)	 DS: 23 DI: 84 A: 110	F-24 HYUN. ACCENT (CAJA) KIA SEPHIA (CAJA)	 DS: 22.3 DI: 67.8 A: 100.55
F-25 FUELLE PEUG. 405 (CAJA)	 DS: 24 DI: 75.5 A: 102.6	F-26 FUELLE NISSAN V-16 (CAJA)	 DS: 25 DI: 80 A: 104
F-27 FUELLE CHEVR. CAVALIER 2,4 4 X 4 (CAJA)	 DS: 29.6 DI: 90 A: 109	F-28 FUELLE NISSAN D-21 (CAJA)	 DS: 24 DI: 83 A: 110
F-29 FUELLE TOYOTA TERCEL (CAJA)	 DS: 25 DI: 79.5 A: 92.3	F-30 FUELLE CIT. BERLINGO	 DS: 34 DI: 78 A: 96
F-31 FUELLE DAIHATSU TERIOS	 DS: 21.5 DI: 66.5 A: 92.5	F-32 FUELLE REN. MEGANE FUELLE PEUGEOT (CAJA) 35 X 77 MM	 DS: 34 DI: 80 A: 104
F-33 FUELLE HYUNDAI H-100 FILTRO DE AIRE	 DS: 58.3 A: 310 DI: 66	F-34 FUELLE SUB. IMPRESA FUELLE SUB. OUTBACK	 DS: 22 DI: 69 A: 102
F-35 FUELLE TOY. TERCEL (RUEDA)	 DS: 35.3 DI: 76.5 A: 94	F-36 FUELLE NISSAN TIIDA (RUEDA)	 DS: 24 DI: 72 A: 98.5

FUELLE HOMOCINETICA Y CAJA

F-37 PEUG. 206 - 307 - 405 (RUEDA) 25 X 74 MM		DS: 24 DI: 77 A: 103		
--	---	---	--	--

FUELLE DIRECCIÓN

FD-01 DATSUN 1,8 DERECHO LARGO		DS: 11 DI: 33 A: 195	FD-02 DATSUN 1,8 B/ANCHA MITUSBISHI; HYUN. EXEL DAIHATSU 850	 DS: 11 DI: 46 A: 143
FD-03 NISSAN SUNNY CORTO DATSUN; KIA SEPHIA REN. 12 LT; FORD DEL REY PEUGEOT 405 - 305 GT		DS: 11 DI: 33 A: 154	FD-04 FUELLE DIRECCION CHARADE ANGOSTO	 DS: 11 DI: 33 A: 153
FD-05 FUELLE DIRECCION CHARADE ANCHO		DS: 12 DI: 38 A: 148	FD-06 FUELLE DIRECCION RENAULT 5	 DS: 11 DI: 34 A: 160
FD-07 FUELLE DIRECCION RENAULT 18		DS: 11 DI: 40 A: 152	FD-08 KIA HIDRAULICO NISSAN V-16 HIDRAULICO DODGE CARAVAN - DAKOTA FORD TAURUS	 DS: 13 DI: 48 A: 215
FD-09 FUELLE DIRECCION SUZUKI BALENO		DS: 14 DI: 40 A: 180	FD-10 FUELLE DIRECCION SUZUKI FRONTER	 DS: 12 DI: 47 A: 123
FD-11 FUELLE DIRECCION CHEVETTE		DS: 17 DI: 38 A: 185	FD-12 FUELLE DIRECCION SUBARU LOYALE	 DS: 12 DI: 65 A: 175
FD-13 FUELLE DIRECCION TOYOTA TERCEL LARGO		DS: 11 DI: 41 A: 175	FD-14 FUELLE DIRECCION TOYOTA TERCEL CORTO	 DS: 12 DI: 49 A: 132



FUELLE DIRECCIÓN

FD-15 FUELLE DIRECCION CHEVR. MONZA		DS: 41 DI: 53 A: 165	FD-16 FUELLE DIRECCION SUZ. SUPER CARRY ANG.		DS: 16 DI: 36 A: 123
FD-17 FUELLE DIRECCION SUZ. SUPER CARRY ANCH.		DS: 27 DI: 36 A: 124	FD-18 CUBRE POLVO N° 1 CUBRE ROTULA 25 X 10 MM		DS: 10 DI: 24 A: 22
FD-19 CUBRE POLVO N° 2 CUBRE ROTULA		DS: 13 DI: 30 A: 26	FD-20 CUBRE POLVO N° 3		DS: 19 DI: 39 A: 28
FD-21 CUBRE POLVO N° 4 51 X 21 MM		DS: 26 DI: 50 A: 33	FD-22 CUBRE POLVO N° 5 55 X 20 MM		DS: 18 DI: 50 A: 38
FD-23 FUELLE DIRECCION HYUNDAI H-100		DS: 15 DI: 53 A: 190	FD-24 FUELLE DIRECCION FORD RANGER HIDRAUL.		DS: 14 DI: 62 A: 235
FD-25 FUELLE DIRECCION NISSAN V-16 HIDRAULICO		DS: 14.5 DI: 55 A: 220			

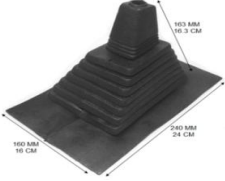
FUELLE PALANCA

FP-01 FUELLE PALANCA UNIVERSAL 160 X 163 X 240 CM				
--	---	--	--	--

GOMA AMORTIGUADOR

CO-01 AMORT. CONICA 5/8		CO-02 AMORT. CONICA DOBLE	
CO-03 AMORT. CONICA 1/2		CO-04 AMORT. FORD CHICO	
CO-05 AMORT. FORD 3/4		CO-06 AMORT. GABRIEL	
CO-07 EST. CARRETILLA CHEVY		CO-08 ESTABIL. OPALA CHEVETTE	
CO-09 ESTABILIZADOR LENTEJA		CO-10 ESTABILIZ. UNIVERSAL	
CO-11 ESTABILIZADOR PONY		CO-12 ESTABILIZADOR PEUGEOT	
CO-13 ESTABILIZADOR HYUNDAI 9,5 X 17 X 37,5 MM		CO-14 TOPE CAPOT LUV	
CO-15 TOPE CAPOT NISSAN		CO-16 TOPE CAPOT UNIVERSAL	
CO-17 AMORTIG. SUZUKI		CO-18 AMORT. M. BENZ CHICO 17 X 30 X 32 MM	
CO-19 AMORTIG. FORD GDE. 1'		CO-20 AMORT. M. BENZ GDE. 20 X 38 X 45 MM	
CO-21 ESTABILIZADOR HYUNDAI 11 X 18 X 40 MM		CO-22 AMORTIGUADOR CAMION GOREN 63 X 66 MM	











GOMAS ALZA ESPIRAL

<p>GR-0 CUÑA ESPIRAL GRANDE</p>		<p>GR-1 CUÑA ESPIRAL CHICA</p>	
<p>GR-2 GOMA ALZA ESPIRAL SUZUKI TOYORA YARIS</p>		<p>GR-3 GOMA ALZA ESPIRAL LADA</p>	
<p>GR-4 GOMA ALZA ESPIRAL</p>		<p>GR-5 GOMA ALZA ESPIRAL</p>	
<p>GR-6 GOMA ALZA ESPIRAL</p>		<p>GR-7 GOMA ALZA ESPIRAL PEUGEOT</p>	
<p>GR-8 GOMA ALZA ESPIRAL DAEWOO</p>		<p>GR-9 GOMA ALZA ESPIRAL CAMIONETA</p>	
<p>GR-10 GOMA ALZA ESPIRAL NISSAN</p>		<p>GR-11 GOMA ALZA ESPIRAL HYUNDAI H-100</p>	

GOMAS TENSORES

<p>TS-01 TENSOR CHARADE</p>		<p>TS-02 TENSOR CHEVROLET GEMINIS</p>	
<p>TS-03 TENSOR DATSUN</p>		<p>TS-04 TENSOR DATSUN 120Y - 140Y</p>	
<p>TS-05 TENSOR FIAT 125</p>		<p>TS-06 TENSOR FIAT 147</p>	

GOMAS TENSORES

<p>TS-07 TENSOR FIAT FIORINO</p>		<p>TS-08 TENSOR FORD RANGER</p>	
<p>TS-09 TENSOR HYUNDAI H-100 ALTO</p>		<p>TS-10 TENSOR HYUNDAI H-100 BAJO</p>	
<p>TS-11 TENSOR HONDA</p>		<p>TS-12 TENSOR HONDA ACCORD</p>	
<p>TS-13 TENSOR HYUNDAI EXEL TENSOR HYUNDAI AXEL</p>		<p>TS-14 TENSOR KIA</p>	
<p>TS-15 TENSOR L-300 ANTIGUA</p>		<p>TS-16 TENSOR L-300 NUEVA</p>	
<p>TS-17 TENSOR LADA SAMARA</p>		<p>TS-18 TENSOR LUV</p>	
<p>TS-19 TENSOR LUV ANTIGUA</p>		<p>TS-20 TENSOR MAZDA</p>	
<p>TS-21 TENSOR MITSUBISHI L-200</p>		<p>TS-22 TENSOR NISSAN</p>	
<p>TS-23 TENSOR NISSAN D-21</p>		<p>TS-24 TENSOR SUBARU 1600</p>	
<p>TS-25 TENSOR SUBARU 1600 - 1700</p>		<p>TS-26 TENSOR SUBARU LOYALE</p>	
<p>TS-27 TENSOR SUZUKI FRONTE</p>		<p>TS-28 TENSOR SUZUKI FURGON</p>	

GOMAS TENSORES

<p>TS-29 TENSOR SUZUKI CARRY</p>		<p>TS-30 TENSOR TOYOTA</p>	
<p>TS-31 TENSOR VOLVO GRANDE</p>		<p>TS-32 TENSOR VOLVO SCANIA ALTO</p>	
<p>TS-33 TENSOR VOLVO SCANIA BAJO</p>		<p>TS-34 SOP. REDIADOR UNIVERSAL</p>	
<p>TS-35 SOPORTE RADIADOR</p>		<p>TS-36 SOPORTE RADIADOR</p>	
<p>TS-37 SOP. RAD. NISSAN V-16</p>		<p>TS-38 SOP. RAD. HYUNDAI H-100</p>	
<p>TS-39 MANITO DE ACOPLA</p>		<p>TS-40 TENSOR CHEVR. SPARK</p>	
<p>TS-41 TENSOR DAEWOO TICO</p>		<p>TS-42 SOP. RAD. CHEVR. SPARK</p>	
<p>TS-43 SOP. RAD. SUZUKI SWIFT</p>		<p>TS-44 SEP. DIREC. TOYOTA YARIS</p>	
<p>TS-45 TENSOR HYUNDAI EON</p>			

BARRA ESTABILIZADORA

<p>BEST-01 BARRA CHEVETTE</p>		<p>BEST-02 BARRA CHEVROLET C-30</p>	
--	---	--	---

BARRA ESTABILIZADORA

<p>BEST-03 BARRA CHEVROLET C-10</p>		<p>BEST-04 BARRA CHEVROLET S-10</p>	
<p>BEST-05 BARRA DAEWOO</p>		<p>BEST-06 BARRA PUNTA DAEWOO</p>	
<p>BEST-07 BARRA DAEWOO NUBIRA</p>		<p>BEST-08 BARRA DAIHATSU YIRO</p>	
<p>BEST-09 BARRA DATSUN 150 I</p>		<p>BEST-10 BARRA FIAT 125</p>	
<p>BEST-11 BARRA FIAT FIORINO</p>		<p>BEST-12 BARRA FORD CARGO</p>	
<p>BEST-13 BARRA SUPER CARRIER</p>		<p>BEST-14 BARRA HYUNDAI H-100 AÑO 95' - 03'</p>	
<p>BEST-15 BARRA HYUNDAI H-200 26 MM (AÑO 2000)</p>		<p>BEST-16 BARRA HYUNDAI PORTER</p>	
<p>BEST-17 BARRA HYUNDAI ACCENT</p>		<p>BEST-18 BARRA HYUN. ELANTRA</p>	
<p>BEST-19 BARRA HYUNDAI H-1</p>		<p>BEST-20 BARRA HYUNDAI SONATA</p>	

BARRA ESTABILIZADORA

<p>BEST-21 BARRA HYUN. STELLAR</p>		<p>BEST-22 BARRA KIA AVELLA</p>	
<p>BEST-23 BARRA KIA POP</p>		<p>BEST-24 BARRA KIA CERES</p>	
<p>BEST-25 BARRA KIA BESTA</p>		<p>BEST-26 BARRA LADA</p>	
<p>BEST-27 BARRA LADA SAMARA</p>		<p>BEST-28 BARRA LUV (BUJE) AÑO 89' - ACTUAL</p>	
<p>BEST-29 BARRA LUV ANTIGUA</p>		<p>BEST-30 BARRA MAZDA</p>	
<p>BEST-31 BARRA MAZDA</p>		<p>BEST-32 BARRA LUV MILENIUM</p>	
<p>BEST-33 BARRA CHEVROLET MONZA 14 MM</p>		<p>BEST-34 BARRA CHEVROLET MONZA 17 MM</p>	
<p>BEST-35 BARRA CHEVR. MONZA TRASERO</p>		<p>BEST-36 BARRA NISSAN SUNNY DELANTERO</p>	
<p>BEST-37 BARRA NISSAN SUNNY DERECHO</p>		<p>BEST-38 BARRA NISSAN SENTRA</p>	

BARRA ESTABILIZADORA

BEST-39 BARRA NISSAN TERRANO		BEST-40 BARRA NISSAN V-16	
BEST-41 BARRA NISSAN V-16 DELANTERO		BEST-42 BARRA NISSAN V-16 TRASERO	
BEST-43 BARRA OPEL CORSA		BEST-44 BARRA RENAULT 11	
BEST-45 BARRA RENAULT 18		BEST-46 BARRA RENOLETA	
BEST-47 BARRA SUBARU		BEST-48 BARRA SUBARU	
BEST-49 BARRA SUBARU LEGACY		BEST-50 BARRA SUBARU LEGACY GRANDE	
BEST-51 BARRA SUZUKI BALENO		BEST-52 BARRA SUZUKI FRONTE	
BEST-53 BARRA SUZUKI MARUTI		BEST-54 BARRA SUZUKI VITARA	
BEST-55 BARRA TOYOTA 20 MM		BEST-56 BARRA TOYOTA 22 MM	

BARRA ESTABILIZADORA

<p>BEST-57</p> <p>BARRA TOYOTA 24 MM</p>		<p>BEST-58</p> <p>BARRA TOYOTA 28 MM</p>	
<p>BEST-59</p> <p>BARRA TOYOTA TERCEL</p>		<p>BEST-60</p> <p>BARRA TOYOTA TERCEL AÑO 98'</p>	
<p>BEST-61</p> <p>BARRA VOLKSWAGEN</p>		<p>BEST-62</p> <p>BARRA HYUNDAI EXEL</p>	
<p>BEST-63</p> <p>BARRA HYUNDAI ACCENT CHICA</p>		<p>BEST-64</p> <p>BARRA SUBARU</p>	
<p>BEST-65</p> <p>BARRA CHEVROLET MONZA TRASERO</p>		<p>BEST-66</p> <p>BARRA CHEROKEE</p>	
<p>BEST-67</p> <p>BARRA DODGE 33 MM</p>		<p>BEST-68</p> <p>BARRA DODGE 28 MM</p>	
<p>BEST-69</p> <p>BARRA SUZUKI BALENO</p>		<p>BEST-70</p> <p>BARRA RENAULT 19</p>	
<p>BEST-71</p> <p>BARRA MITSUBISHI ROSA</p>		<p>BEST-72</p> <p>BARRA MITSUBISHI ROSA</p>	
<p>BEST-73</p> <p>BARRA FORD RANGER</p>		<p>BEST-74</p> <p>BARRA FORD RANGER</p>	

BARRA ESTABILIZADORA

<p>BEST-75 BARRA MITSUBISHI L-200</p>		<p>BEST-76 BARRA DAKOTA TRASERO</p>	
<p>BEST-77 BARRA HYUNDAI H-100 AÑO 95' - ACTUAL</p>		<p>BEST-78 BARRA MAHINDRA 28 MM</p>	
<p>BEST-79 BARRA SUBARU OUTBACK</p>		<p>BEST-80 BARRA NISSAN TIIDA</p>	
<p>BEST-81 BARRA HYUNDAI ELANTRA</p>		<p>BEST-82 BARRA HYUNDAI EXEL</p>	
<p>BEST-83 BARRA HYUNDAI 18,5 MM</p>		<p>BEST-84 BARRA HYUNDAI GETZ 19 MM</p>	
<p>BEST-85 BARRA HYUNDAI MATRIX 22 MM</p>		<p>BEST-86 BARRA HYUNDAI ACCENT 24 MM</p>	
<p>BEST-87 BARRA MAHINDRA CHICA TRASERO 22,5 MM</p>		<p>BEST-88 BARRA CHEVROLET NP-300 17,3 MM</p>	
<p>BEST-89 BARRA SSANGYONG 30 MM</p>		<p>BEST-90 BARRA SUBARU</p>	
<p>BEST-91 BARRA HYUNDAI EON</p>			



















BUJES

B-01 SOPORTE CAJA HYUNDAI H-100	 A: 12.5 B: 16.5 C: 66.4 D: 46 E: 78.7	B-02 SOPORTE MOTOR HYUNDAI ELANTRA	 A: 10 B: 10 C: 70.5 D: 40.5 E: 55
B-03 SOPORTE MOTOR CHEROOKE	 A: 15.3 B: 15.3 C: 57.5 D: 58 E: 64.7	B-04 SOPORTE MOTOR HYUNDAI GALLOPER	 A: 16 B: 16 C: 65 D: 40.7 E: 61
B-05 PAQ. RESORTE VOLKSWA. FORD CARGO CAMION	 A: 19 B: 19 C: 53 D: 80.5 E: 90.2	B-06 BUJE TOYOTA TERCEL	 A: 10.4 B: 10.4 C: 75.2 D: 39.3 E: 70.1
B-07 SOPORTE MOTOR TOYOTA TERCEL	 A: 10 B: 10 C: 70.3 D: 42.7 E: 56.7	B-08 BUJE SUBARU LEGACY	 A: 12 B: 12 C: 37.3 D: 45.4 E: 55.3
B-09 BUJE BANDEJA TRASERA SUBARU LEGACY	 A: 19.8 B: 24.8 C: 56.3 D: 42.2 E: 53	B-10 SOPORTE MOTOR CAJA MITSUBISHI ROSA	 A: 10.3 B: 10.3 C: 60.5 D: 41.1 E: 60.6
B-11 SOPORTE MOTOR HYUNDAI SONATA	 A: 10.5 B: 11 C: 80 D: 60.5 E: 82.3	B-12 SOPORTE MOTOR MITSUBISHI ECLIPSE	 A: 12.3 B: 12.3 C: 90.4 D: 46 E: 83.6
B-13 SOPORTE MOTOR MITSUBISHI	 A: 13 B: 13 C: 80.6 D: 51 E: 82.8	B-14 SOPORTE MOTOR HYUNDAI EXEL	 A: 16.6 B: 16.6 C: 70.1 D: 38.3 E: 56
B-15 SOPORTE MOTOR HYUNDAI ACCENT	 A: 16.5 B: 16.2 C: 80 D: 41 E: 60	B-16 HYUN. SONATA - POTRON	 A: 12.5 B: 12.5 C: 89.5 D: 53.9 E: 83.6
B-17 PAQUETE RESORTE SUZUKI SAMURAI	 A: 12 B: 12 C: 52 D: 41.8 E: 60.8	B-18 PAQUETE RESORTE SUZUKI VITARA	 A: 13 B: 13 C: 52.7 D: 50.4 E: 65.8

BUJES

<p>B-19 SOPORTE MOTOR NISSAN V-16</p>	 <p>A: 10 B: 10 C: 74 D: 41.2 E: 61.3</p>	<p>B-20 SOPORTE MOTOR NISSAN V-16</p>	 <p>A: 11.4 B: 11.4 C: 73.8 D: 41.6 E: 61.4</p>
<p>B-21 SOPORTE MOTOR NISSAN V-16</p>	 <p>A: 10.4 B: 10.4 C: 82.2 D: 42 E: 60.8</p>	<p>B-22 BUJE BANDEJA HYUN. ACCENT - EXEL 82 X 10 X 60 MM</p>	 <p>A: 12.2 B: 12.2 C: 36 E: 55.6</p>
<p>B-23 VIELETA DELANTERA SUBARU LEGACY</p>		<p>B-24 VIELETA DELANTERA SUBARU LEGACY</p>	
<p>B-25 SOPORTE MOTOR NISSAN V-16</p>	 <p>A: 11.3 B: 11.3 C: 81.8 D: 41.9 E: 61</p>	<p>B-26 BUJE BANDEJA DAEWOO NUBIRA</p>	
<p>B-27 BUJE BANDEJA DAEWOO NUBIRA</p>		<p>B-28 BANDEJA INFERIOR CHEVROLET LUV</p>	 <p>A: 14.6 B: 14.6 C: 36 D: 58.7 E: 63.4</p>
<p>B-29 BANDEJA SUPERIOR CHEVROLET LUV 89'</p>	 <p>A: 18 B: 18 C: 36.3 D: 41 E: 45.3</p>	<p>B-30 BANDEJA SUPERIOR CHEVROLET LUV</p>	 <p>A: 18.3 B: 18.3 C: 38.4 E: 46.5</p>
<p>B-31 BANDEJA SUPERIOR LADA</p>	 <p>A: 14 B: 17.2 C: 30.3 E: 40</p>	<p>B-32 BANDEJA INFERIOR LADA</p>	 <p>A: 16.4 B: 16 C: 32.4 E: 52.1</p>
<p>B-33 PAQUETE RESORTE KIA TOPIC DELANTERO</p>	 <p>A: 18 B: 18 C: 48.5 D: 70 E: 80.9</p>	<p>B-34 PAQUETE RESORTE KIA BESTA</p>	 <p>A: 17.4 B: 17.4 C: 48.7 D: 60.6 E: 70.7</p>
<p>B-35 BUJE KIA BESTA</p>	 <p>A: 14.2 B: 14.2 C: 48.6 D: 59.7 E: 71</p>	<p>B-36 PAQUETE RESORTE HYUNDAI H-100</p>	 <p>A: 14.5 B: 14.5 C: 55.5 D: 70 E: 79.4</p>

BUJES

B-37 BANDEJA INFERIOR KIA	 A: 24 B: 24.3 C: 46 E: 75.5	B-38 BANDEJA INFERIOR HYUNDAI H-100 C/GOLILLA	 A: 17.3 B: 17.9 C: 46.3 E: 68.5
B-39 BANDEJA INFERIOR KIA C/GOLILLA	 A: 17.3 B: 17 C: 45.2 E: 78	B-40 BANDEJA SUPERIOR KIA CHICO	 A: 22.2 B: 22.2 C: 45.2 E: 41.7
B-41 BANDEJA SUPERIOR HYUNDAI H-100	 A: 24 B: 24 C: 46.6 E: 40.6	B-42 PAQUETE RESORTE KIA TITAN	 A: 15.6 B: 16.5 C: 33.3 D: 69.3 E: 76
B-43 PAQ. RESORTE TRASERO KIA TITAN	 A: 19.5 B: 19.5 C: 37.2 D: 70.7 E: 75.5	B-44 BANDEJA CENTRAL KIA PREGGIO 2.7	 A: 16 B: 16 C: 40 D: 79.7 E: 90
B-45 BANDEJA INFERIOR HYUNDAI H-100	 A: 24 B: 24 C: 52.3 E: 75.4	B-46 BANDEJA SUPERIOR MITSUBISHI L-300	 A: 22.4 B: 22.4 C: 46.5 E: 40.5
B-47 PAQUETE RESORTE KIA PREGGIO 2000, KIA BESTA	 A: 14.4 B: 14.4 C: 52.8 D: 61.3 E: 71.2	B-48 BANDEJA TRASERA CHEVROLET MONZA	 A: 12 B: 12 C: 58 D: 66 E: 75
B-49 PAQUETE RESORTE SUZUKI CARRY	 A: 12 B: 12 C: 45.7 D: 49.3 E: 65.2	B-50 BUJE BANDEJA MAZDA 323	 A: 18 B: 18 C: 38 D: 39.6 E: 50.7
B-51 BUJE BANDEJA HONDA CHICO	 A: 12.3 B: 12.3 C: 36 D: 30 E: 46	B-52 BUJE BANDEJA HONDA GRANDE	 A: 12.7 B: 12.7 C: 37.3 D: 33.2 E: 49.7
B-53 BANDEJA TRASERA CHEVROLET CAVALIER	 A: 14 B: 14 C: 60.3 D: 27.2 E: 50.6	B-54 BANDEJA INFERIOR OPEL CORSA	 A: 16 B: 16 C: 61.5 D: 28 E: 60.2



BUJES

B-55 BANDEJA INFERIOR HYUN. H-100 S/GOLILLA	 A: 15.7 B: 15.7 C: 46.3 E: 69.6	B-56 BUJE CHARMAN	 A: 12.7 B: 12.7 C: 49.6 E: 38.1
B-57 BUJE CHARMAN	 A: 22.3 B: 22.3 C: 37.3 E: 42.6	B-58 BUJE DAIHATSU DELTA TOYOTA	 A: 22.7 B: 22.7 C: 37.5 E: 42
B-59 BUJE DAIHATSU FURGON	 A: 17.3 B: 17.3 C: 33.8 E: 34.2	B-60 BUJE DAIHATSU JEEP	 A: 15.5 B: 15.5 C: 31 E: 41.8
B-61 BUJE DATSUN	 A: 10.5 B: 10.5 C: 22.4 E: 34.5	B-62 BUJE FORD GRANDE	 A: 20 B: 20 C: 42,8 E: 43
B-63 BUJE FORD CHICO	 A: 19.4 B: 19.4 C: 32.6 E: 45	B-64 BUJE LARGO HYUNDAI L-100 - L-300	 A: 15.5 B: 15.5 C: 27 E: 54.5
B-65 BUJE CORTO HYUNDAI L-100 - L-300	 A: 16 B: 16 C: 27.5 E: 43.5	B-66 BUJE KIA	 A: 19 B: 19 C: 42.6 E: 38.5
B-67 BUJE KIA	 A: 17.8 B: 17.8 C: 32 E: 38.8	B-68 BUJE LAND CRUSSIER TOYOTA	 A: 18 B: 18 C: 35 E: 44.8
B-69 BUJE LUV GRANDE	 A: 18 B: 18 C: 39.7 E: 36.7	B-70 BUJE LUV CHICO	 A: 18 B: 18 C: 30 E: 33.4
B-71 BUJE HYUNDAI L-100	 A: 12.5 B: 12.5 C: 23.8 E: 44.6	B-72 BUJE HYUNDAI L-100	 A: 12.3 B: 12.3 C: 25 E: 31



















BUJES

B-73 BUJE NISSAN	 A: 18.3 B: 18.3 C: 39.4 E: 36.5	B-74 BUJE NISSAN D-21	 A: 17.4 B: 17.4 C: 37.9 E: 37.5
B-75 BUJE NISSAN - DATSUN	 A: 15.4 B: 15.4 C: 32.7 E: 36.6	B-76 BUJE NISSAN	 A: 19.5 B: 19.5 C: 30.8 E: 35
B-77 BUJE PONY	 A: 15.5 B: 15.5 C: 44.7 E: 32.8	B-78 BUJE PONY GRANDE	 A: 15 B: 15 C: 24.8 E: 44.3
B-79 BUJE PONY CHICO	 A: 15.5 B: 15.5 C: 24.8 E: 31.6	B-80 BUJE SUZUKI	 A: 15 B: 15 C: 41.5 E: 33
B-81 PAQ. RESORTE SUZUKI ST90	 A: 13 B: 13 C: 30 E: 30.8	B-82 BUJE TOYOTA HILUX	 A: 18 B: 18 C: 30 E: 55.2
B-83 BUJE TOYOTA	 A: 17.5 B: 17.5 C: 29.7 E: 40	B-84 BUJE TOYOTA - ISUZU MITSUBISHI ROSA	 A: 21.7 B: 21.7 C: 29.7 E: 46.8
B-85 PAQ. RESORTE MERCEDES BENZ	 A: 30.4 B: 30.4 C: 58.2 D: 82.8 E: 91	B-86 B. TENSOR HYUN. TUCSON SUBARU IMPRESA - LOYALE	 A: 12.2 B: 12.2 C: 55 D: 40.8 E: 60.7
B-87 BUJE TENSOR BANDEJA MAHINDRA	 A: 16 B: 16 C: 53.4 D: 38.9 E: 46.6	B-88 SOPORTE MOTOR SUZUKI BALENO	 A: 12 B: 12 C: 80 D: 40.5 E: 55.5
B-89 BUJE BANDEJA TOYOTA COROLLA 98'	 A: 14.2 B: 14.2 C: 68.9 D: 30.8 E: 60.2	B-90 BUJE BANDEJA SUBARU	 A: 13.8 B: 13.8 C: 60.4 D: 35.3 E: 40.9

BUJES

<p>B-91 BUJE TENSOR BANDEJA MAHINDRA</p>	 <p>A: 16 B: 16 C: 53.3 D: 39.2 E: 45.9</p>	<p>B-92 BUJE MITSUBISHI TUBO LARGO</p>	 <p>A: 12 B: 12 C: 34 D: 33 E: 58</p>
<p>B-93 SOP. CAJA MITSU. L-200 MITSU. CATANA - DAKAR</p>	 <p>A: 10.2 B: 10.2 C: 57.3 D: 26.6 E: 51</p>	<p>B-94 PAQUETE RESORTE KIA 2.7</p>	 <p>A: 12 B: 12 C: 48.2 D: 44 E: 57.5</p>
<p>B-95 SOP. MOTOR SUBARU IMPRESA TOYOTA NEW YARIS</p>	 <p>A: 18.7 B: 18.7 C: 60.3 D: 32.4 E: 59.6</p>	<p>B-96 BUJE TOYOTA YARIS GDE.</p>	 <p>A: 12.2 B: 12.2 C: 54.8 D: 27 E: 57.8</p>
<p>B-97 PAQUETE RESORTE MERCEDES BENZ ASTRO</p>	 <p>A: 24.2 B: 24.2 C: 60.9 D: 81 E: 96.4</p>	<p>B-98 PAQUETE RESORTE HYUNDAI H-1</p>	 <p>A: 16 B: 16 C: 55.5 D: 70 E: 79.4</p>
<p>B-99 TOPES MACK 19 MM</p>	 <p>A: 19 B: 19 E: 39.8</p>	<p>B-100 TOPES MACK 16 MM</p>	 <p>A: 15.8 B: 15.8 E: 39</p>
<p>B-101 PAQ. RESORTE LUV</p>	 <p>A: 14.2 B: 14.2 C: 40.2 D: 61.8 E: 69</p>	<p>B-102 BUJE NISSAN TILA - TIIDA</p>	 <p>A: 16.8 B: 16.8 C: 41 D: 48.9 E: 80.3</p>
<p>B-103 BUJE TOYOTA - ISUZU</p>	 <p>A: 16 B: 16 C: 40.5 E: 45.5</p>	<p>B-104 BUJE NEW HYUDAI H-1</p>	 <p>A: 15.7 B: 15.7 C: 60.4 D: 70.1 E: 81</p>
<p>B-105 SOP. ANTIVIBRATORIO M. BENZ CONICO ECOLOG.</p>	 <p>A: 10.3 B: 10.3 E: 30.3</p>	<p>B-106 SOP. ANTIVIBRATORIO M. BENZ ECOLOGICO</p>	 <p>A: 14 B: 14 C: 51 E: 42.2</p>
<p>B-107 BUJE SUBARU OUTBACK</p>	 <p>A: 13.7 B: 13.7 C: 66 D: 37.5 E: 67.4</p>	<p>B-108 BUJE BJA. NISSAN TIIDA</p>	 <p>A: 12.2 B: 12.2 C: 58 D: 23.2 E: 53.5</p>

BUJES

B-109 BUJE NISSAN PATHFINDER	 <p>A: 14.2 B: 14.2 C: 50.5 D: 46.2 E: 60.3</p>	B-110 BUJE MAZDA SEMIEJE	 <p>A: 16 B: 16 C: 48.3 D: 61.7 E: 76.8</p>
B-111 SOPORTE MOTOR HYUNDAI SONATA	 <p>A: 10.5 B: 10.2 C: 81.3 D: 60.8 E: 82.6</p>	B-112 SOPORTE MOTOR SSANGYONG	 <p>A: 12 B: 12 C: 69.7 D: 37 E: 39</p>
B-113 BUJE TIPO JAPONES	 <p>A: 12.5 B: 12.5 C: 34.2 E: 45.5</p>	B-114 BUJE MAZDA 6	 <p>A: 12.5 B: 12.5 C: 40.3 D: 41.8 E: 58.5</p>
B-115 VIELETA NISSAN TRASERO	 <p>A: 10 B: 10 C: 34 D: 29.4 E: 40.7</p>	B-116 BUJE SUBARU OUTBACK	 <p>A: 12 B: 12 C: 34.2 D: 32.9 E: 42.9</p>
B-117 BUJE CHANGAN	 <p>A: 14 B: 14 C: 34.8 E: 42.4</p>	B-118 BUJE SUZUKI APV TRASERO	 <p>A: 14 B: 14 C: 40 E: 39.9</p>
B-119 BUJE SUZUKI APV DELANT.	 <p>A: 12 B: 12 C: 29.3 E: 45</p>	B-120 BUJE BANDEJA DIMAX	 <p>A: 14 B: 14 C: 43.2 D: 38.9 E: 46</p>
B-121 BUJE MITSU. DELICA HYUNDAI STAREX	 <p>A: 14.5 B: 14.5 C: 46.8 D: 55 E: 68</p>	B-122 NISSAN TERRANO TRASERO	 <p>A: 14.3 B: 14.3 C: 45.4 D: 47 E: 55.3</p>
B-123 TENSOR MOTOR SSANGYONG	 <p>A: 12.4 B: 12.4 C: 46 D: 28.5 E: 38.8</p>	B-124 BUJE BANDEJA CHICO NISSAN VERSA - MARCH	 <p>A: 12 B: 12 C: 44.4 D: 26.5 E: 46.3</p>
B-125 BUJE BANDEJA GRANDE NISSAN VERSA - MARCH	 <p>A: 19 B: 19 C: 53 D: 28.2 E: 50</p>	B-126 TENSOR SSANGYONG	 <p>A: 12 B: 12 C: 69.8 D: 37 E: 40.6</p>

BUJES

B-127 PAQ. RESORTE KIA FRONTIER CORTO	 <p> A: 17 B: 17 C: 31.5 E: 38.6 </p>	B-128 PAQ. RESORTE KIA FRONTIER LARGO	 <p> A: 17.3 B: 17.3 C: 31.4 E: 44.2 </p>
B-129 SOPORTE MOTOR SUZUKI - HYUNDAI	 <p> A: 10.2 B: 10.2 C: 80.5 D: 39.6 E: 55.3 </p>	B-130 BUJE NISSAN PATHFINDER	 <p> A: 14.3 B: 14.3 C: 50.3 D: 46.3 E: 59 </p>
B-131 BUJE NEW HYUNDAI H-1	 <p> A: 14 B: 14 C: 60.2 D: 70 E: 80.7 </p>	B-132 PAQ. RESORTE TRASERO SUBARU LEGACY	 <p> A: 14 B: 14 C: 38.3 D: 30.7 E: 41.5 </p>

TOPES DE CHASSIS

TCH-01 TOPE CHASSIS PERNO N° 3		TCH-02 TOPE CHASSIS PERNO N° 4	
TCH-03 TOPE CHASSIS FIAT 125		TCH-04 TOPE CHASSIS TOYOTA	
TCH-05 TOPE CHASSIS HYUN. H-100		TCH-06 TOPE CHASSIS PONY	
TCH-07 TOPE PAQUETE RESORTE KIA		TCH-08 TOPE PAQUETE RESORTE KIA DELTA	
TCH-09 TOPE PAQUETE RESORTE KIA		TCH-10 TOPE PAQUETE RESORTE LUV	



TOPES DE CHASSIS

<p>TCH-11 TOPE CHASSIS LUV</p>		<p>TCH-12 TOPE BANDEJA LAND CRUSSIER</p>	
<p>TCH-13 TOPE CHASSIS CONICO LARGO</p>		<p>TCH-14 TOPE CHASSIS CHEVR. LUV REDONDO</p>	

BUJES DE ACOPLADOS

<p>BA-01 BUJE ACOPLADO 28 MM</p>		<p>BA-02 BUJE ACOPLADO 30 MM</p>	
<p>BA-03 BUJE ACOPLADO 32 MM</p>		<p>BA-04 BUJE ESCALONADO 7/8</p>	
<p>BA-05 BUJE ESCALONADO 1'</p>		<p>BA-06 BUJE ESCALONADO CARNAVAL</p>	
<p>BA-07 BUJE ESCALONADO CAMION DAF</p>			

TIRANTES CAPOT

<p>TC-01 TIRANTE CAPOT C/METAL CHICO</p>		<p>TC-02 TIRANTE CAPOT S/METAL CHICO</p>	
<p>TC-03 TIRANTE CAPOT C/METAL GRANDE</p>			

SOPORTE CABINA

SC-01 SOPORTE CABINA CHEVROLET REDONDO		SC-02 SOPORTE CABINA FORD	
SC-03 SOPORTE CABINA SUBARU PEGASO		SC-04 SOPORTE CABINA MERCEDES BENZ	
SC-05 SOPORTE CABINA GOMA SOLA		SC-06 SOPORTE CABINA LUV ALTA	
SC-07 SOPORTE CABINA LUV BAJA		SC-08 SOPORTE CABINA CHEVROLET	
SC-09 SOPORTE CABINA CHEVROLET C-10 AMERICANA GRANDE		SC-10 SOPORTE CABINA FORD RANGER	

TAPONES DE ACEITE

TPA-01 TAPONES DE ACEITE CHEVETTE		TPA-02 TAPONES DE ACEITE 40 MM	
TPA-03 TAPONES DE ACEITE 45 MM		TPA-04 TAPONES DE ACEITE 55 MM	

TOPES DE ELEVADOR

TRJ-01 TOPES ROLLING JACK 130 X 13 MM		TRJ-02 TOPES ROLLING JACK 130 X 26 MM	
TRJ-03 TOPES ROLLING JACK 131 X 42 MM		TRJ-04 TOPES ROLLING JACK 120,5 X 100 X 153 MM	

TOPES DE PARACHOQUES







<p>TP-01</p> <p>TOPE PARACHOQUE CUADRADO GRANDE 197 X 50 X 171 MM</p>		<p>TP-02</p> <p>TOPE PARACHOQUE CUADRADO CHICO 145 X 50 X 120 MM</p>	
<p>TP-03</p> <p>TOPE PARACHOQUE MERCEDES BENZ CHICO</p>		<p>TP-04</p> <p>TOPE PARACHOQUE MERCEDES BENZ GRANDE</p>	
<p>TP-05</p> <p>TOPE PARACHOQUE DIAMANTE</p>			

GOMAS VARIAS

<p>MDA-01</p> <p>MUELA DE ACOPLE</p>			
---	--	--	--

**A: PERNO
B: ALTO
C: ANCHO
D: HILO**

SOPORTE MOTOR

<p>MOT-01</p> <p>SOPORTE MOTOR VOLVO CHICO</p>	 <p>A: 12.5 B: 24 C: 55</p>	<p>MOT-02</p> <p>SOPORTE RADIADOR MERCEDES BENZ 1114</p>	 <p>A: 10 B: 30 C: 65</p>
<p>MOT-03</p> <p>SOPORTE ESCAPE MINI GRANDE</p>	 <p>A: 8 B: 32.4 C: 45.7</p>	<p>MOT-04</p> <p>SOPORTE RADIADOR MERCEDES BENZ 1113</p>	 <p>A: 10 B: 35 C: 43</p>
<p>MOT-05</p> <p>SOPORTE MOTOR VOLVO ALTO</p>	 <p>A: 12 B: 37,5 C: 56</p>	<p>MOT-06</p> <p>SOPORTE MOTOR LAND ROVER</p>	 <p>A: 10 B: 36 C: 62</p>

SOPORTE MOTOR

**A: PERNO
B: ALTO
C: ANCHO
D: HILO**

<p>MOT-07 SOPORTE MOTOR VOLVO ALTO ESPECIAL</p>	 <p>A: 11 B: 54 C: 51</p>	<p>MOT-08 SOPORTE MOTOR FORD TAUNUS</p>	 <p>A: 10 B: 41 C: 72</p>
<p>MOT-09 SOPORTE MOTOR FIAT 125</p>	 <p>A: 10 B: 49 C: 73</p>	<p>MOT-10 SOPORTE MOTOR FIAT 125 ITALIANO</p>	 <p>A: 10 B: 41.2 C: 77.4</p>
<p>MOT-11 SOPORTE MOTOR OPALA - CHEVETTE</p>	 <p>A: 10 B: 54 C: 63</p>	<p>MOT-12 SOPORTE MOTOR VOLVO SCANIA</p>	 <p>B: 55 C: 94 D: 11</p>
<p>MOT-13 COMPRESOR BAJO PERNO - PERNO</p>	 <p>A: 15.7 B: 43.3 C: 96.9</p>	<p>MOT-14 COMPRESOR ALTO PERNO - PERNO</p>	 <p>A: 16 B: 60 C: 97</p>
<p>MOT-15 COMPRESOR PERNO TUERCA ALTA</p>	 <p>A: 16 B: 61 C: 97 D: 16</p>	<p>MOT-16 SOPORTE MOTOR CHEVROLET 14000</p>	 <p>D: 15 - 13 B: 57.3 C: 104.6</p>
<p>MOT-17 SOPORTE MOTOR CHEVROLET C-10</p>		<p>MOT-18 SOPORTE MOTOR CHARADE G-20</p>	
<p>MOT-19 TIRANTE MOTOR SUZUKI FRONTE</p>		<p>MOT-20 SOPORTE MOTOR SUBARU BAJO - DAIHATSU</p>	 <p>A: 10 B: 33 C: 46</p>
<p>MOT-21 SOPORTE MOTOR FURGON DAIHATSU IZQ.</p>	 <p>A: 10 B: 42 C: 42</p>	<p>MOT-22 SOPORTE MOTOR DAIHATSU FURGON</p>	 <p>A: 10 B: 41.5</p>
<p>MOT-23 SOPORTE MOTOR DATSUN 140 - 150Y</p>		<p>MOT-24 SOPORTE MOTOR FORD FIESTA</p>	 <p>A: 10 B: 42</p>

A: PERNO
B: ALTO
C: ANCHO
D: HILO

SOPORTE MOTOR

<p>MOT-25 SOPORTE MOTOR SUBARU FURGON</p>		<p>MOT-26 SOPORTE MOTOR FIAT 673</p>	 <p>A: 13 B: 59 C: 66</p>
<p>MOT-27 SOPORTE MOTOR KIA TOPIC - KIA BESTA</p>		<p>MOT-28 SOPORTE MOTOR KIA FRONTIER 2.7</p>	
<p>MOT-29 SOPORTE MOTOR SUZUKI VITARA</p>		<p>MOT-30 SOPORTE MOTOR FORD CORCEL - DEL REY</p>	
<p>MOT-31 SOPORTE MOTOR PEUGEOT 404</p>		<p>MOT-32 SOPORTE MOTOR SINCA MIL</p>	
<p>MOT-33 SOPORTE MOTOR MITSUBISHI L-100</p>		<p>MOT-34 SOPORTE MOTOR TOYOTA HILUX</p>	
<p>MOT-35 SOPORTE MOTOR TOYOTA</p>		<p>MOT-36 SOPORTE MOTOR PONY</p>	
<p>MOT-37 SOPORTE MOTOR FORD F-100 - F-350</p>		<p>MOT-38 SOPORTE MOTOR HYUNDAI H-100</p>	
<p>MOT-39 SOPORTE MOTOR SUZUKI FURGON ST-90</p>		<p>MOT-40 SOPORTE MOTOR MAX COURE IZQUIERDO</p>	
<p>MOT-41 SOPORTE MOTOR MAX COURE DERECHO</p>		<p>MOT-42 SOPORTE MOTOR SUZUKI FRONTE</p>	

A: PERNO
B: ALTO
C: ANCHO
D: HILO

SOPORTE MOTOR

MOT-43 SOPORTE MOTOR PERKIN CHICO		MOT-44 SOPORTE MOTOR PERKIN GRANDE	
MOT-45 SOPORTE MOTOR PERKIN DER. CON TAPA		MOT-46 SOPORTE MOTOR DAIHATSU CHARMAN	
MOT-47 SOPORTE MOTOR SUBARU LOYALE		MOT-48 SOPORTE MOTOR SUBARU LEGACY	
MOT-49 SOPORTE MOTOR MITSUBISHI ROSA GRANDE		MOT-50 SOPORTE MOTOR TOYOTA DINA	
MOT-51 SOPORTE MOTOR SUZUKI GRAN VITARA		MOT-52 SOPORTE MOTOR DODGE 500 TRASERO	
MOT-53 SOPORTE MOTOR MITSUBISHI ROSA FUSO		MOT-54 SOPORTE MOTOR FIAT 125 PERNO 1/2	 A: 13 B: 50 C: 73
MOT-55 SOPORTE CAJA CHEVROLET AUTOMATICO		MOT-56 SOPORTE CAJA CHEVROLET MECANICO	



BARRA DE DIRECCION

BDIR-01 BARRA DIRECCION NISSAN MEC. HIDRAULICO		BDIR-02 BARRA DIRECCION CREMALLERA OPEL CORSA	
BDIR-03 BARRA DIRECCION NISSAN V-15 SIN FILTRO		BDIR-04 BARRA AMORTIGUADOR VOLKSWAGEN; MERCEDES BENZ CREMALLERA GRANDE	

TOPES DE PORTALON

TPN-01 TOPE PORTALON KIA GRANDE		TPN-02 TOPE PORTALON KIA MEDIANO	
TPN-03 TOPE PORTALON KIA CHICO			

GOMA CUBRE FOCO

GF-01 CUBRE FOCO GRANDE		GF-02 CUBRE FOCO CHICO	
-----------------------------------	---	----------------------------------	---

FLECTOR DE DIRECCION

FDD-01 FLECTOR DE DIRECCION CHEVROLET C/TELA		FDD-02 FLECTOR DE DIRECCION PEUGEOT C/TELA	
FDD-03 FLECTOR DE DIRECCION JAPONES C/TELA			

REGATONES

CODIGO	DESCRIPCION
REG-01	REGATONES 3/8'
REG-02	REGATONES 1/2'
REG-03	REGATONES 5/8'
REG-04	REGATONES 3/4'
REG-05	REGATONES 7/8'
REG-06	REGATONES 1'
REG-07	REGATONES 1 1/4'
REG-08	REGATONES 1 1/2'
REG-09	REGATONES 2'
REG-10	REGATONES 15 X 15 MM
REG-11	REGATONES 20 X 20 MM
REG-12	REGATONES 20 X 30 MM
REG-13	REGATONES 20 X 30 MM ESCALERA

REGATONES

CODIGO	DESCRIPCION
REG-14	REGATONES 20 X 40 MM
REG-15	REGATONES 25 X 25 MM
REG-16	REGATONES 30 X 30 MM
REG-17	REGATONES 40 X 40 MM
REG-18	REGATONES 50 X 50 MM
REG-19	TOPE BASTON 16 MM
REG-20	TOPE BASTON 19 MM

RETENES

CODIGO	DESCRIPCION
RTT-01	GOMA TERMOSTATO CHICO
RTT-02	GOMA TERMOSTATO MEDIANO
RTT-03	GOMA TERMOSTATO GRANDE
RTI-01	GOMA DE INYECTOR CHICO
RTI-02	GOMA DE INYECTOR MEDIANO
RTI-03	GOMA DE INYECTOR GRANDE C/ESTRIA



CARDAN

CODIGOS	DESCRIPCION
CAR-01	CARDAN CHEVETTE
CAR-02	CARDAN CHEVROLET LUV
CAR-03	CARDAN FIAT 673
CAR-04	CARDAN FORD 600
CAR-05	CARDAN FORD 800
CAR-06	CARDAN FORD RANGER
CAR-07	CARDAN FROYLAN MACK GRANDE
CAR-08	CARDAN HYUNDAI MISTIC / MITSUBISHI ROSA
CAR-09	CARDAN HYUNDAI STELLAR 1600
CAR-10	CARDAN HYUNDAI STELLAR 200
CAR-11	CARDAN KIA
CAR-12	CARDAN MERCEDES BENZ 608 MACISO
CAR-13	CARDAN MERCEDES BENZ 1113 ANILLO
CAR-14	CARDAN MERC. BENZ 1114 ANILLO CHICO
CAR-15	CARDAN PEGASO
CAR-16	CARDAN TOYOTA HI / LUV